

PART NUMBER

**KWG177286**

REV.

INITIAL

**Electrical Data****RoHS Compliant**

Frequency Range      26.50 - 40.00 GHz.  
 Power                    0.5 Watts  
 VSWR                    ≤ 1.02 Max.

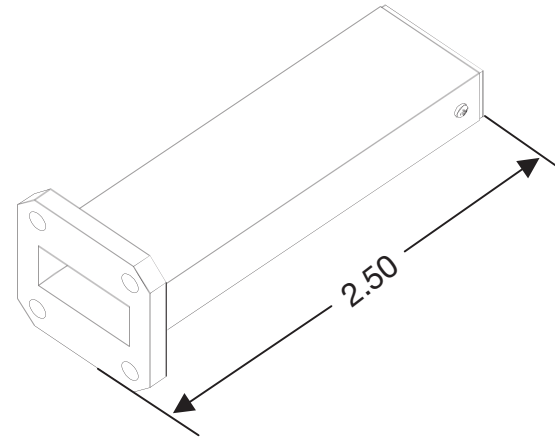

**VSWR and Frequency Range Specifications**  
 are for reference and are dependant on cable  
 type and other application specific conditions

Drawing not to scale. Dimensions for reference only      Units: inches

WWW.KONNECTRF.COM  
 1-800-790-5887

PART NUMBER

**KWG177286**

DESCRIPTION

**Waveguide Termination, WR28,  
PBR120 Flange with Through Holes**

CAGE CODE

**664U0**

SIGNATURE

X

THIS DRAWING INCLUDING THE  
 DESIGNS IS THE PROPERTY OF  
 KONNECT RF AND IS NOT TO  
 BE USED FOR ANY PURPOSE  
 WITHOUT OUR APPROVAL.