

PART NUMBER

KCC188177

REV.

DATE

COMMENTS

INITIAL

Electrical Data

Impedance	50 Ω
Frequency Range	DC - 12.4 GHz.
Voltage Rating	500 VRMS
Insulation Resistance	5,000 M Ω
Dielectric Withstanding Voltage	750 VRMS
VSWR	1.25 max

Mechanical Data

Temperature Range: -65 °C - 165 °C

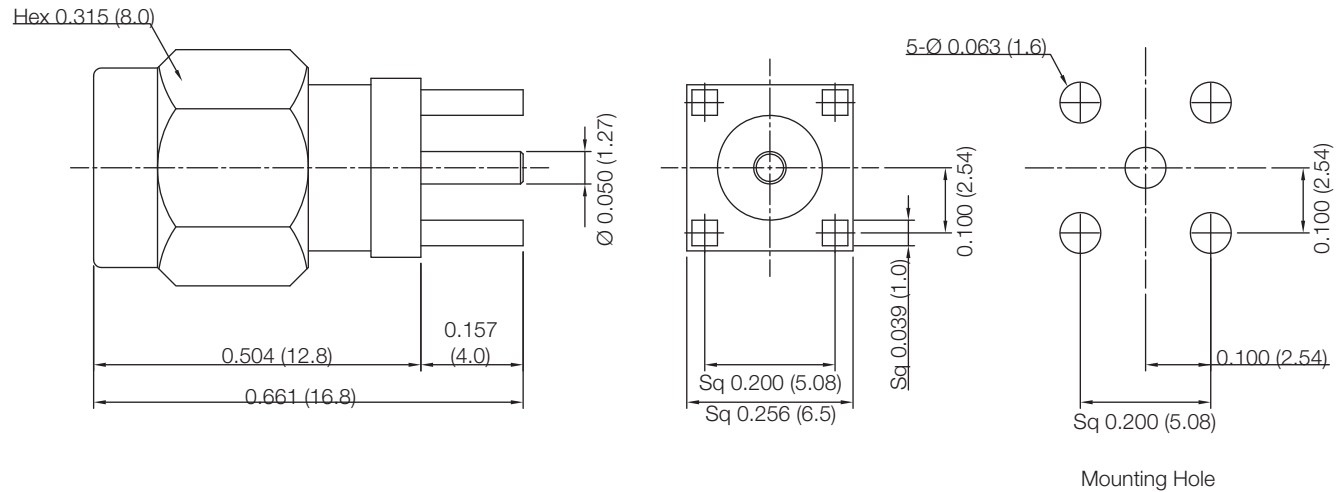
RoHS Compliant

Drawing not to scale. Dimensions for reference only

Units: inches (mm)

Konnect RF

WWW.KONNECTRF.COM
1-800-790-5887

PART NUMBER

KCC188177

DESCRIPTION

SMA Straight Male Plug, 4 Leg PC Board Receptacle

CAGE CODE

664U0

SIGNATURE

X

THIS DRAWING INCLUDING THE
DESIGNS IS THE PROPERTY OF
KONNECT RF AND IS NOT TO
BE USED FOR ANY PURPOSE
WITHOUT OUR APPROVAL.

Component

Body & Coupling Nut
Center Contact
Insulator

Material

Stainless Steel
Brass
PTFE

Plating

Gold
Gold