

PART NUMBER

KAT177361

REV.

DATE

COMMENTS

INITIAL

Electrical Data

Frequency Range 14 - 26.5 GHz.
 Attenuation 0-30 dB (+/-1.5 dB Flat)
 Insertion Loss 0.5 max @ 18 GHz
 0.75 max @ 26 GHz
 VSWR 1.8 max

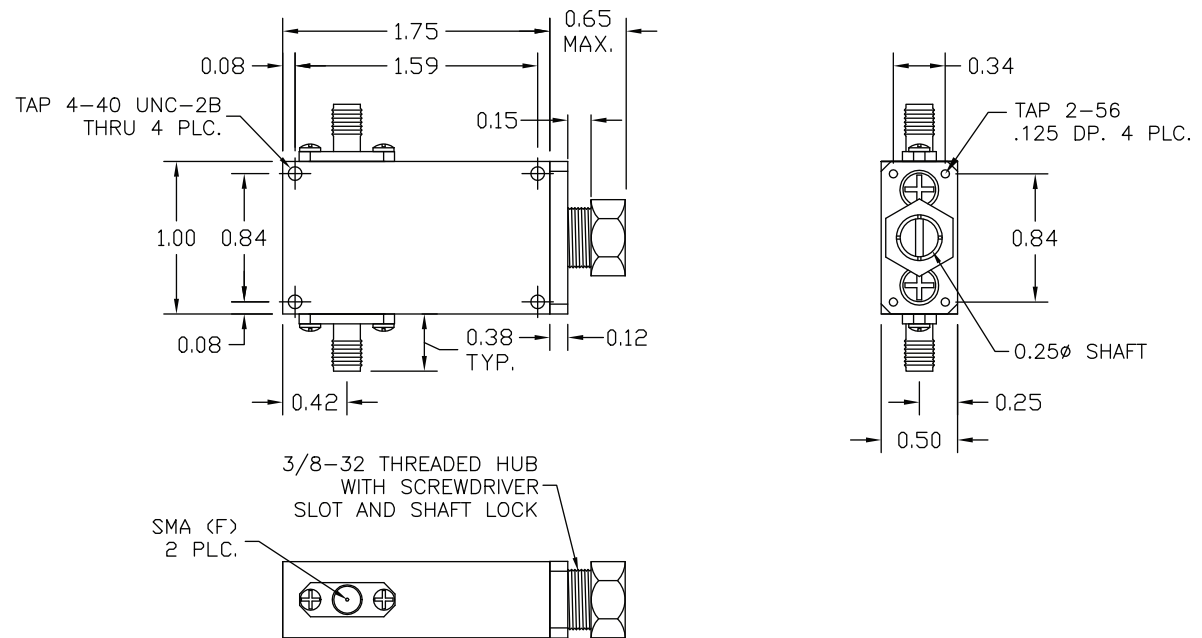
RoHS Compliant

Drawing not to scale. Dimensions for reference only

Units: inches

Konnect RF

WWW.KONNECTRF.COM
 1-800-790-5887

PART NUMBER

KAT177361

DESCRIPTION

Variable Attenuator, SMA Female

CAGE CODE

664U0

SIGNATURE

X

THIS DRAWING INCLUDING THE
 DESIGNS IS THE PROPERTY OF
 KONNECT RF AND IS NOT TO
 BE USED FOR ANY PURPOSE
 WITHOUT OUR APPROVAL.